











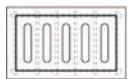

LK 531.5
± 14.5 kg





LK 532.4
± 11.0 kg





LK 632.5
± 16.0 kg





LK 641.5 (LK 13)
± 22.0 kg



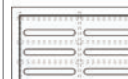

LK 641.75
± 33.0 kg

LK 643.10 (LK15)
± 39.0 kg

LK 663.5
± 35.5 kg

Mild Steel Frame / Galvanized Steel Frame

Length \ Width	300 mm	400 mm	600 mm
	500 mm	MS 53.50	
600 mm	MS 63.50	MS 64.50 MS 64.75 MS 64.100	MS 66.50
800 mm			MS 86.50 MS 86.75 MS 86.100

Product Ordering Code:

Type	length	width	height
MS	5	3	50

MS - Mild steel angle bar with anti rust paint
GV - Galvanized angle bar